

westelettric



ELECTRICAL RUBBER BOXES

COMPANY PROFILE

Westelettric s.r.l. was founded in 1987 as a manufacturer and distributor for specialist electrical industrial safety devices.

Rubber and polycarbonate were chosen for the basic raw materials due to their exceptional performance on both building and industrial sites.

Initially production started with power boxes and transformers, along with portable and wall mounted boxes. These were needed to guarantee great safety and durability. These products were later supplemented by portable and fixed lighting equipment.

In 1992 the companies products received the Italian Mark of Quality IMQ (MI) after extensive testing, including GLOW-WIRE tests to withstand temperatures up to 960°C on the mains power boxes.

Between 1994 and 1998 CSI (MI) successfully tested the raw material (rubber) in accordance with standards CEI 20-37/1-2-3 for induced combustion. This standard allows our products to be used in public areas and public show sites.

During 1995 tests were conducted for the granting of CE marking, following standards CEI 17-13/1 CEI 17-13/4 according to European Procedure CEE 73-23 and CEE 93-68. The successful certification confirms that our products conform to Standard CEE 17-13/4 (EN 60439-4). Furthermore our products have been certified as conforming to Standard CEE 17-13/4 (EN 60439-4) for electrical boxes ASC for use on building sites and similar.

Next came ISO 9001:2000 certification of quality assurance that we obtained on 15/11/2003 (Certified by C.S.Q.). We were then certified for our military equipment by the Italian Military Authorities (Comando Logistico 2° Divisione dell'Aeronautica Militare) in accordance with Standards CLA-Q-2110 (AQAP-2110 UNI EN ISO-9001). On 21/5/2003 we received code A9402 as a certified NATO supplier by the Ministry of Defence.

At the end of 1999 the company created 5 commercial divisions.

- ⚡ **INDUSTRIAL DIVISION**
- ⚡ **BUILDING DIVISION**
- ⚡ **MACHINERY LIGHTING AND ACCESSORIES DIVISION**
- ⚡ **MILITARY DIVISION**
- ⚡ **SOUND AND LIGHTING SERVICES DIVISION**



ELECTRICAL RUBBER BOXES

Westelettric is a specialist manufacturer of bespoke equipment and electrical distribution systems. If you require any further information about our products, please contact us to find the most popular solution to satisfy your requirements.

MAIN PRODUCTION:

- Wall-mounting mains distribution assemblies in rubber boxes
- Portable mains distribution assemblies in rubber boxes
- Wall electrical transformer assemblies in rubber boxes
- Portable electrical transformer assemblies in rubber boxes
- Main distribution assemblies on a trolley
- Portable and fixed lighting
- Machinery and workshops lighting
- Portable cable-winder in rubber
- Wall mounted wall cable winder
- Special electrical cables
- Industrial plugs and sockets
- Welding connectors and accessories

MAIN CLIENTS:

- Shipyards
- Army forces
- Fire departments
- Building companies
- Machinery builders
- Steel plants
- Heavy industries
- Service audio video etc.



⚡ SERIES 21

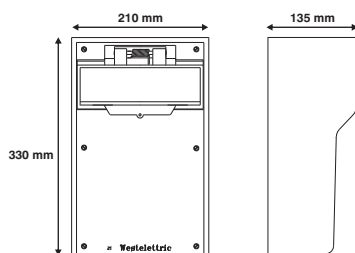

PART # 215203
 Protection conforming to IP54
 DIN 40050. Provided with
 Polycarbonate window available
 in 10 mod. DIN (17,5mm.)

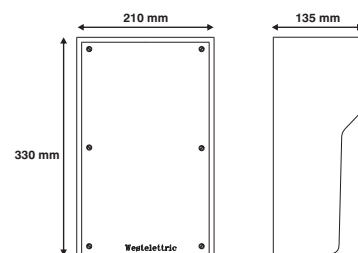

PART # 215303
 Protection conform to IP54
 DIN 40050. Without window

⚡ SERIES 22

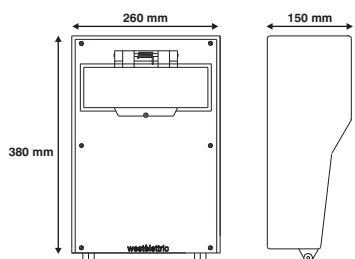

PART # 225203
 Protection conforming to IP54 DIN
 40050. Provided with Polycarbonate
 window available in 12 mod. DIN
 (17,5mm.)

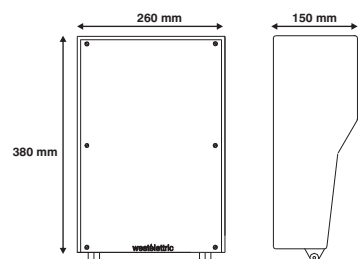

PART # 225303
 Protection conform to IP54 DIN
 40050. Without window

⚡ SERIES COMP

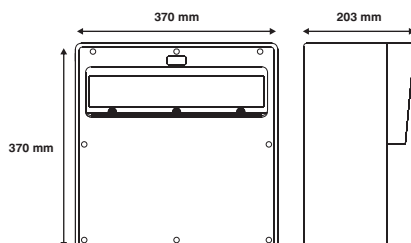

PART # COMP18M
 Protection conforming to IP54
 DIN 40050. Provided with
 Polycarbonate window
 available in 18 mod. DIN
 (17,5mm.)

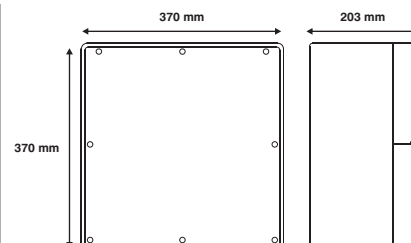

PART # COMP18M/SC
 Protection conform to IP54 DIN
 40050. Without window

⚡ SERIES 460

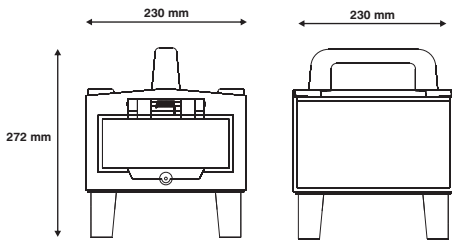

PART # 465203
Protection conforming to IP54
DIN 40050. Provided with
Polycarbonate window available
in 10 mod. DIN (17,5mm.)

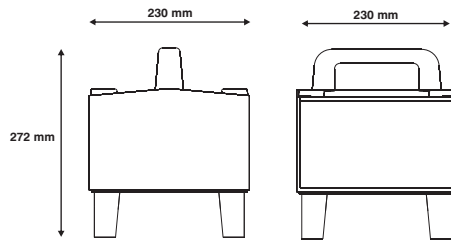

PART # 465303
Protection conform to IP54 DIN
40050. Without window



⚡ SERIES 460-A

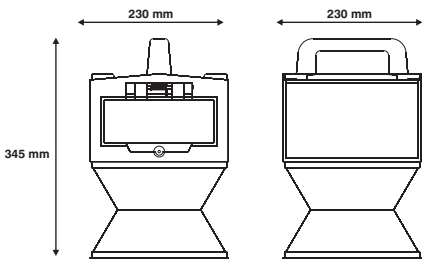

PART # 465400
Protection conform to IP54 DIN
40050. Provided with Polycarbonate
window available in 10 mod. DIN
(17,5mm.)

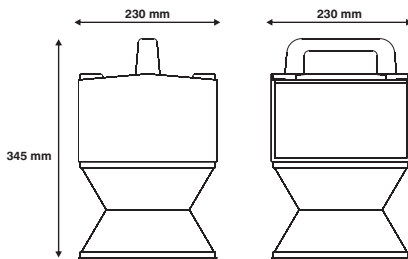

PART # 465600
Protection conform to IP54 DIN
40050. Without window



⚡ SERIES 470

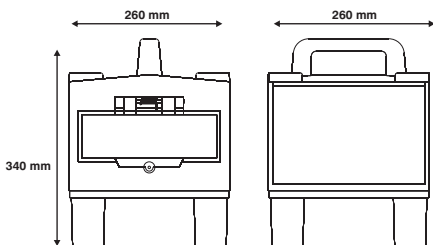

PART # 475203
Protection conform to IP54 DIN
40050. Provided with
Polycarbonate window available
in 12 mod. DIN (17,5mm.)

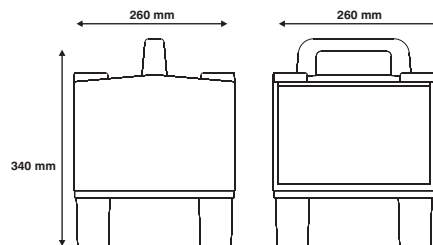

PART # 475303
Protection conform to IP54 DIN
40050. Without window



⚡ SERIES 420

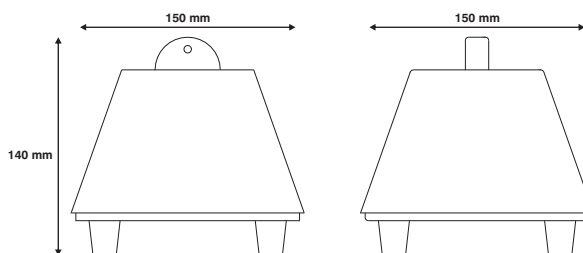

PART # 425300
Protection conform to IP54 DIN 40050



⚡ SERIES 440

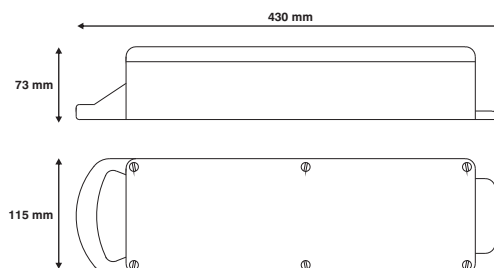

PART # 440 000 000
Protection conform to IP54 DIN 40050



⚡ SERIES 230 - 231

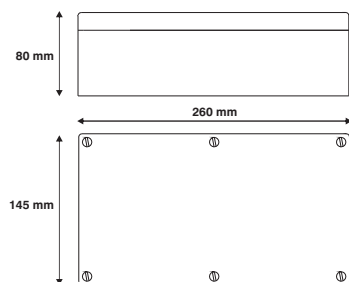

PART # 230 000 000
Protection conform to IP54 DIN 40050

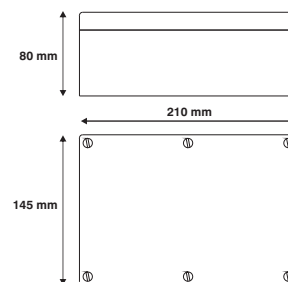

PART # 231 000 000
Protection conform to IP54 DIN 40050





⚡ SERIES 560

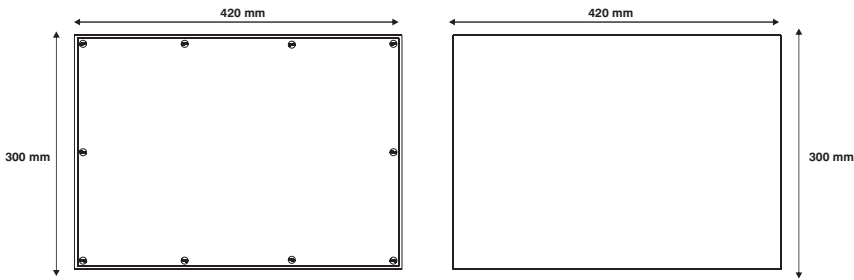

PART # 560 000 000

The ultimate in industrial power. Shock resistant, tough and safe. Highly protected and reinforced with double insulation. Suitable for industrial, construction and workshop use. Protection to IP 65 with gasket (DIN 40050). Wall mounted or portable. Available with Westelettric rubber accessories.



⚡ SERIES 570

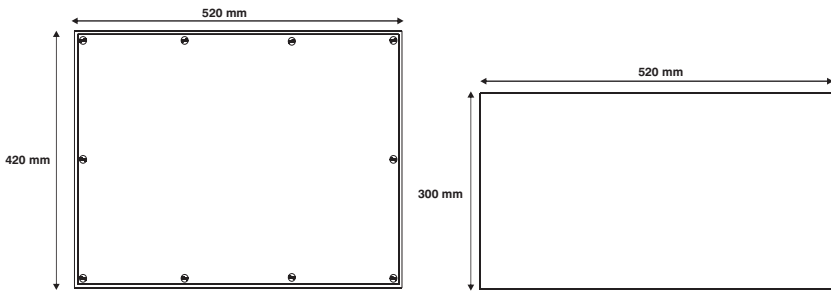

PART # 570 000 000

The ultimate in industrial power. Shock resistant, tough and safe. Highly protected and reinforced with double insulation. Suitable for industrial, construction and workshop use. Protection to IP 65 with gasket (DIN 40050). Wall mounted or portable. Available with Westelettric rubber accessories.



⚡ RUBBER FEET FOR RUBBER BOX

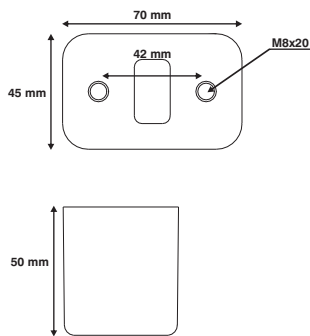

PART # 5057

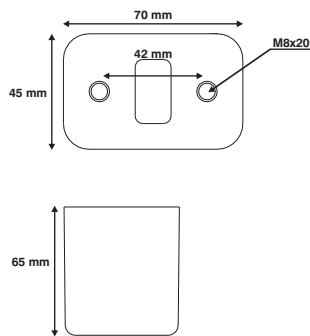

PART # 5057N



Rubber feet with threaded brass inserts heat injected during the moulding process



⚡ LABEL HOLDERS

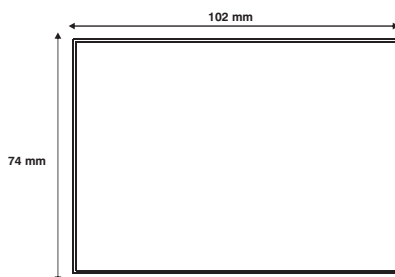

ITEM # 3212PX10274
Label holder in transparent polycarbonate

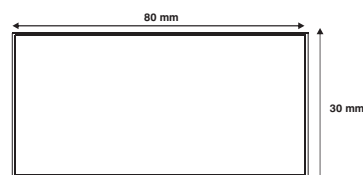

ITEM # 3212PX8030
Label holder in transparent polycarbonate



⚡ Y - CORD SPLITTER SERIES VP - WEST



LINE IN PLUG	LINE OUT SOCKET
CEE 16A	2X CEE 16A
CEE 16A	3X CEE 16A
CEE 32A	2X CEE 16A
CEE 32A	2X CEE 32A

The Y-cord splitter VP-WEST allows temporary connection of additional devices using a single power outlet to ensure the use of safe connections. The compact dimensions of this item ensure easy storage & handling. Available with plugs and sockets to IP 44 or IP 67. Available in black and standard colours. Can be fitted with neoprene or PVC cable of various lengths.



⚡ HAND INSPECTION LAMP BODY



ACCESSORIES

ITEM CODE	DESCRIPTION
1150002	tempered glass
1150003	lamp holder G4 - GY 6,35
1150004	spot beam reflector
1160004	flood beam reflector
1150020	thumb switch with three positions
1150300	rubber cap for the switch
1150009	metallic hook
1150007	protection grip
186005780	beam reflector 50W 28V G.E. PAR 36

ITEM # 1150005
Inspection lamp body constructed of self-extinguishing rubber. Abrasion resistant, non-flammable and fluid resistant.



WINDOW 10/12 MOD.

Rubber support with polycarbonate window. DIN (17.5 mm). Protection conforming to IP 67 DIN 40050.

Part #	x mm	y mm	z mm	mod.
5410	198	96	29	10
5412	295	130	38	12

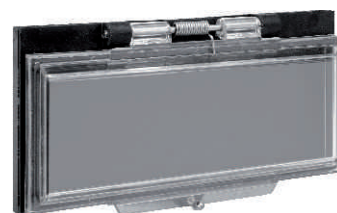
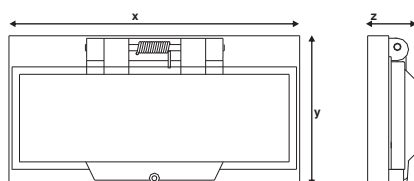

WINDOW 2/4/6/8/13/18 MOD.

PART # 5410200C

Rubber support with polycarbonate window. DIN (17.5 mm). Protection conforming to IP 67 DIN 40050.

Part #	x mm	y mm	z mm	mod.
5410200	49	93	25	2
5404P	85	93	25	4
5406P	121	93	25	6
5408P	157	93	25	8
5413P	247	93	25	13
5418P	337	93	25	18

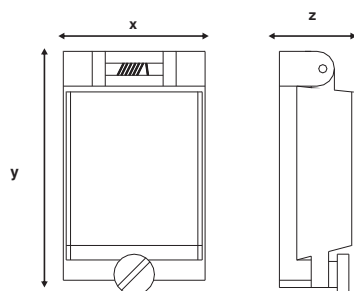

RUBBER GRID

PART # 5021

Rubber ventilation grid for boxes

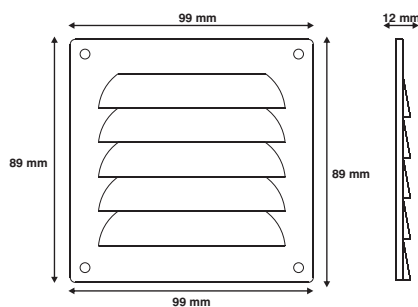

RUBBER HANDLE

PART # 5010

Rubber handle
Specific hard mould

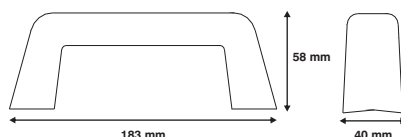

HANDLE

ART. 5014200

Thermoplastic handle for box Series 42

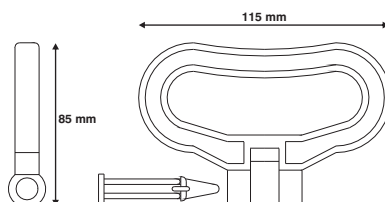

CABLE GLAND

ART. 509

Rubber cable gland for outlet appliances. Available with different cable diameters.
Protection conform to IP54 DIN 40050

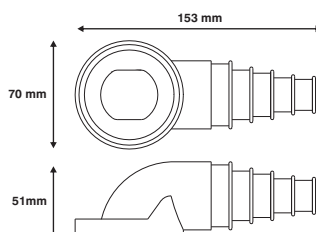

⚡ LAMP SERIES 145



	CAGE LAMP HOLDER IP2X	LAMP 145 IP54	LAMP 145 WITH CURRENT THIEF IP2X	LAMP 145 WITH TROUGHWIRED IP54
HALOGEN 24	Not	Max 20W	Max 20W	Max 20W
E27 24/48/110/230V	Max 100W	Max 60W	Max 60W	Max 60W
NEON 230V	Not	E27 230V	not available	E27 230V
24V	Not	32W 24V	32W 24V	32W 24V
48V	Not	32W 48V	32W 48V	32W 48V
EMERGENCY 24/48V	Not	18W 24V or 48V (Emergency lighting)	18W 24V or 48V (Emergency lighting)	not available

Lamp with cap made of:

Polycarbonate transparent cap to protect and support the bulb or the fluorescent tube. Unbreakable and self extinguishing. The cap is oil, grease and acid proof and it has been designed to be UVA ray resistant. Its shape allows protection of the bulb from collision and accidental contacts. It is totally transparent to let the light pass through. The upper cover is made of unbreakable thermoplastic resin. It has a rubber O ring gasket to give a high degree of protection. Red cap available for special uses.

⚡ UNBREAKABLE PORTABLE FLUORESCENT LAMP SERIES 120 (DULUX FLUORESCENT PIPE)

Outer tube made of unbreakable 50 mm Ø 1.5 mm thick transparent polycarbonate. Clamping bands to guarantee a better seal to the external tube. Cable gland with anti-tear and torsion device incorporated in the cap. Supplied with electronic ballast working at AC -5% +15% of nominal voltage with temperature range from -15°C to +40°C. High frequency operation to reduce any stroboscopic effect. Provided of 10 m. cable type H07RN-F, colour black, with plug CEE with ergonomic grip and thermoplastic inner parts. Class of protection IP55. Handgrip and cap made of water tight self-extinguishing rubber.



ITEM	MOBILE PLUG	CABLE H07RN-F	VOLTS	POWER
120012120N	CEE P17 16A 24V 2P	10m 2x1,5mmq	24V	11W
120052120N	CEE P17 16A 24V 2P	10m 2x1,5mmq	24V	18W
120032120N	CEE P17 16A 24V 2P	10m 2x1,5mmq	24V	36W
120014140N	CEE P17 16A 48V 2P	10m 2x1,5mmq	48V	11W
120054140N	CEE P17 16A 48V 2P	10m 2x1,5mmq	48V	18W
120034140N	CEE P17 16A 48V 2P	10m 2x1,5mmq	48V	36W
120015150N	CEE P17 16A 220V 2P+T	10m 2x1,5mmq	220V	11W
120055150N	CEE P17 16A 220V 2P+T	10m 2x1,5mmq	220V	18W
120035150N	CEE P17 16A 220V 2P+T	10m 2x1,5mmq	220V	36W

www.westelettric.it

westelettric

Via Sciola, 106
55054 Quiesa (LU) Italy
tel. +39 0584 97361
fax +39 0584 975956
info@westelettric.it